

**LightSync Digital** **Wall Sensor**

**Overview**

The LightSync Digital Wall Sensor is a combination dual-tech occupancy sensor and switch station in a single device, featuring infrared and overlapping acoustic sensing. This sensor allows for all-digital, all-CAT5 lighting controls topologies when paired with ILC LightLEEDer EVOs and panels. Configured over the LightSync digital bus for easy set-up and adjustment, it contains the newest digital components and, supports occupancy and vacancy modes in a single device. Selectable dual-tech or PIR-only modes, timeouts, and sensitivities allow adjustments for superior performance in any space. The LSWS matches ILC's LSG3 family of digital switches, is available in the same 6 colors and 12 button configurations supporting: Multi-Zone Dimming, Scene control, combination Scene/Multi-Zone and Non-Dim functionality.



**Features**

- **Made in the USA**
- **Dual Tech** PIR and acoustic sensor
- **Automatic Threshold Control** that filters background noise to fine tune acoustic sensitivity
- **CAT-5/6** ready LightSync Digital device
- **PIR Trigger** with acoustic for extending the On-command state
- **Field Configurable** between multi-zone switches, scene switches and non-dim switches
- **1 to 3 Button** zone control configurations
- **Multi-Zone Dimming** for up to 3 zones and All-Off
- **Scene Station** with dimming for up to 3 scenes and All-Off
- **Scene Multi-Zone** with dimming combo for up to 3 Scene or Zones (1S/3Z, 2S/2Z, 3S/1Z) option
- **Scene Capture** operation for all stations with scene buttons
- **Raise and Lower Buttons** for ramp up and ramp down feature
- **Press and Hold** dimming operation
- **Status LEDs** indicate true state of relay, group, last scene or preset
- **Laser Engraving** is provided, and custom engraving is available, Black and Red buttons are pad-printed
- **Color Change Kit** available for White, Ivory, Gray, Red, Light Almond and Black
- **Addressable** rotary switches
- **Decora®** style single gang switch plate available upon request

**Warranty**

Five-year limited warranty

**Ordering**

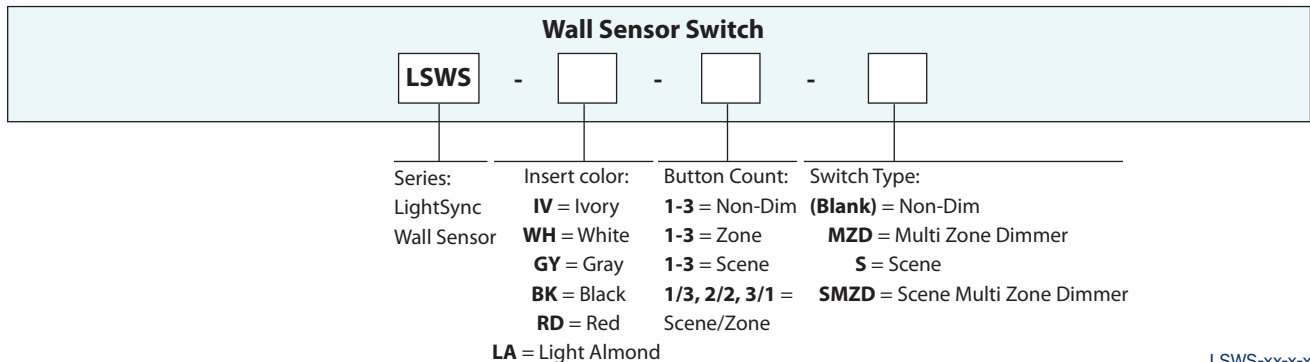

LSWS-xx-x-x  
3-1-2024 Rev.B

**LightSync Digital** **Wall Sensor**

**Physical**

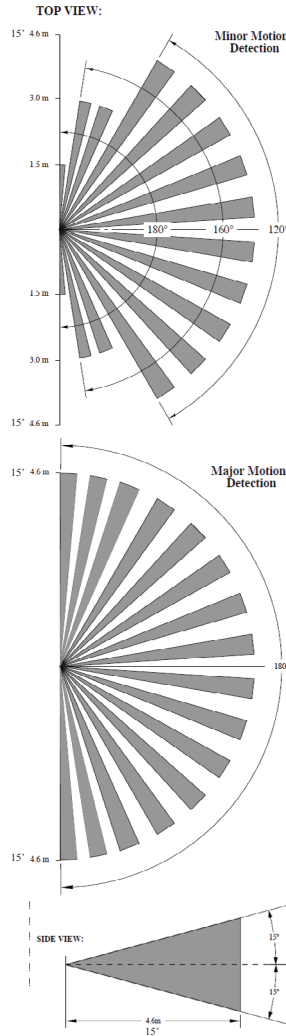
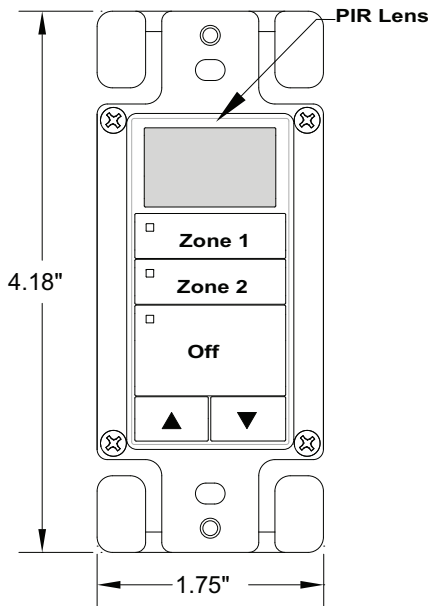

**LSWS MZD Switch**

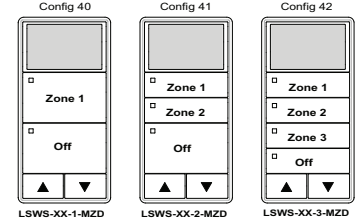

**LSWS Scene Switch**

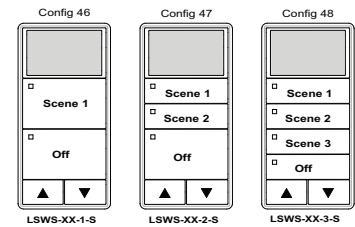

**LSWS Scene/MZD Switch**

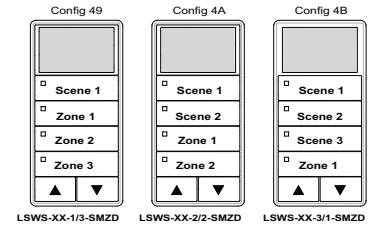

**LSWS Non-Dim Stations**

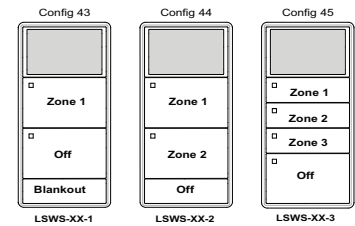

**Specifications**

**Physical:**

- 1.75" W x 4.18" H x 0.875"D
- Standard single gang mounting
- Digital addressing switches
- RJ45 connectors provided for easy connection
- Mounting screws provided
- Laser engraving standard as shown Black and Red buttons are pad-printed
- Custom engraving available

**Operation:**

- Selectable PIR or Dual-Tech operation
- Time delay set form LightLEEDer panel
- An initial PIR event is required to enable acoustic function that then extends the time delay when triggered
- Automatic gain control filters noise
- Up to 15 feet detection for minor and major motion

**Electrical:**

- Powered from the panel or LightSync network

**Operating Environment:**

- Location: Interior space
- Operating Temp.: 0° to 50° C
- Humidity: 10% - 90% Non-condensing
- Atmosphere: Non-explosive/corrosive
- Vibration: Stationary

**Certifications and Approvals:**

- FCC Part 15

LSWS-xx-x-x  
3-1-2024 Rev.B